

Online particle monitor OPM II

Operating instructions
RE 51460-B/02.2022

Replaces: **04.2021**
English



The data specified above serve to describe the product. If there is also information on the use, it is only to be regarded as application examples and proposals. Catalogue information does not constitute warranted properties. The information given does not release the user from the obligation of own judgment and verification. Our products are subject to a natural process of wear and aging.

© This document, as well as the data, specifications and other information set forth in it, are the exclusive property of Hengst Filtration GmbH. It may not be reproduced or given to third parties without its consent.

The original operating instructions were prepared in German.

Inhalt

1	About this documentation	5
1.1	Validity of the documentation	5
1.2	Required and amending documentation	5
1.3	Representation of information	5
1.3.1	Safety instructions	5
1.3.2	Symbols	6
1.3.3	Abbreviations	6
2	Safety instructions	7
2.1	About this chapter	7
2.2	Intended use	7
2.3	Improper use	7
2.4	Qualification of personnel	8
2.5	General safety instructions	8
2.6	Product-specific safety instructions	9
2.7	Warning and information signs at the product	10
3	General information on damage to property and damage to the product	11
4	Scope of delivery	12
5	Information on this product	13
5.1	Performance description	13
5.1.1	General information	13
5.1.2	Measuring principle	13
5.1.3	Display of the measured values	13
5.1.4	Description of the functions	14
5.2	Component overview	15
5.3	Product identification	16
6	Transport and storage	17
6.1	Transporting the online particle monitor	17
6.2	Storing the online particle monitor	17
7	Assembly	18
7.1	Unpacking the online particle monitor	18
7.2	Installation conditions	18
7.2.1	Space required	18
7.2.2	Installation position	18
7.3	Assembling the online particle monitor	19
7.3.1	Hydraulically connecting the online particle monitor	19
7.3.2	Electrically connecting the online particle monitor	20
7.4	Switching output	23
7.5	Conversion of analog current output to atomic number	23
7.6	Sequential data output	24
7.6.1	Sequential	24
7.6.2	Sequenziell2	24
8	Commissioning	25

9	Operation	25
9.1	Operating concept	25
9.2	Menu structure	26
9.3	Operation	27
9.3.1	Operating modes	27
9.3.2	Configuring alarms	28
9.3.3	Configuring the analog output	29
9.3.4	Selecting the standard	29
9.3.5	Configuring the flow	30
9.3.6	Selecting the communication	30
9.3.7	Configuring the display	31
9.3.8	Sensor parameters	31
9.3.9	Setting the language	31
9.4	Communication interfaces	32
9.4.1	Configuration of the serial interface	32
9.4.2	Communication via USB	32
9.4.3	CANopen	33
10	Maintenance and repair	37
10.1	Cleaning and care	37
10.2	Maintenance	37
10.3	Repair	37
10.4	Calibration	37
10.4.1	Calibration note	38
11	Disposal	39
11.1	Environmental protection	39
12	Extension and modification	40
12.1	Optional accessories	40
13	Troubleshooting	41
13.1	How to proceed for troubleshooting	41
13.2	Error messages	41
13.3	Error Code	43
13.4	Errors on the display	43
14	Technical data	44

1 About this documentation

1.1 Validity of the documentation

This documentation applies to the following product:

- R928052298, online particle monitor OPM II

This documentation is intended for assemblers, operators and system end-users. It contains important information on the safe and proper transport, assembly, commissioning, operation, use, maintenance, disassembly and simple troubleshooting of the product.

- ▶ Read this documentation completely and particularly chapter 2 "Safety instructions" and chapter 3 "General information on damage to property and damage to the product" before working with the product.

1.2 Required and amending documentation



- ▶ The product must not be commissioned until you have been provided with the documentation marked with the book symbol  and you have understood and observed it.

Table 1: Required and amending documentation

Title	Document number	Document type
 Online particle monitor OPM II	51460	Data sheet

1.3 Representation of information

Consistent safety instructions, symbols, terms and abbreviations are used in this documentation so that you can quickly and safely work with your product. For a better understanding, they are explained in the following sections.

1.3.1 Safety instructions



In this documentation, safety instructions are given in chapter 2.6 "Product-specific safety instructions" and in chapter 3 "General information on damage to property and damage to the product" and whenever sequences of actions or instructions are explained which bear the danger of personal injury or damage to property. The measures described for the hazard avoidance must be observed.

Safety instructions are set out as follows:

 SIGNAL WORD
<p>Type and source of danger! Consequences in case of non-compliance</p> <ul style="list-style-type: none"> ▶ Hazard avoidance measures ▶ <Enumeration>

- **Warning sign:** Draws attention to the danger
- **Signal word:** Identifies the degree of danger
- **Type and source of danger:** Specifies the type and source of danger
- **Consequences:** Describes the consequences of non-compliance
- **Precaution:** Specifies how the danger can be prevented

Table 2: Risk classes according to ANSI Z535.6-2006

Warning sign, signal word	Meaning
 DANGER	Indicates a dangerous situation which will cause death or severe personal injuries if not avoided.
 WARNING	Indicates a dangerous situation which may cause death or severe personal injuries if not avoided.
 CAUTION	Indicates a dangerous situation which may cause minor or medium personal injuries if not avoided.
NOTICE	Damage to property: The product or the environment could be damaged.

1.3.2 Symbols

The following symbols indicate notices which are not safety-relevant but increase the comprehensibility of the documentation.

Table 3: Meaning of the symbols

Symbol	Meaning
	If this information is not observed, the product cannot be used and/or operated optimally.
▶	Individual, independent action
1.	Numbered instruction:
2.	The numbers indicate that the actions must be carried out one after the other.
3.	

1.3.3 Abbreviations

The following abbreviations are used in this documentation:

Table 4: Abbreviations

Abbreviation	Meaning
OPM	Online Particle Monitor
OZ	Ordinal number (translation of the German OrdnungsZahl)

2 Safety instructions

2.1 About this chapter

The product has been manufactured according to the generally accepted codes of practice. However, there is still the risk of personal injury and damage to property if you do not observe this chapter and the safety instructions in this documentation.

- ▶ Read this documentation completely and thoroughly before working with the product.
- ▶ Keep this documentation in a location where it is accessible to all users at all times.
- ▶ Always include the required documentation when you pass the product on to third parties.

2.2 Intended use

The product is a visual particle monitor based on laser technology.

You may use the product as follows:

- For determining the degree of contamination of the fluid
- For the trend analysis of the fluid cleanliness

The product is only intended for professional use and not for private use.

Intended use includes having read and understood this documentation completely, especially the chapter 2 "Safety instructions".

2.3 Improper use

Any use deviating from the intended use is improper and thus not admissible.

Hengst Filtration GmbH does not assume any liability for damage caused by improper use. The user assumes all risks involved with improper use.

The following cases of foreseeable misuse are also regarded as being improper:

- The displacement of other media than those specified in chapter 14 "Technical data".
- The application outside the performance limits specified in chapter 14 "Technical data".

2.4 Qualification of personnel

The activities described in this documentation require basic knowledge of electrics and hydraulics as well as knowledge of the appropriate technical terms. In order to ensure safe use, these activities may only be carried out by a corresponding expert or an instructed person under the direction and supervision of an expert.

Experts are those who can recognize potential hazards and apply the appropriate safety measures due to their professional training, knowledge and experience, as well as their understanding of the relevant conditions pertaining to the work to be undertaken. An expert must observe the relevant specific professional rules and have the necessary hydraulic expert knowledge.

Hydraulic expert knowledge means, amongst others:

- Reading and completely understanding hydraulic schemes,
- In particular, completely understanding the correlations regarding the safety equipment and
- Having knowledge of the function and set-up of hydraulic components,
- Assembling and disassembling hydraulic and mechanical parts,
- Commissioning hydraulic systems and assemblies.

2.5 General safety instructions

- Observe the valid regulations on accident prevention and for environmental protection.
- Observe the safety regulations and provisions of the country where the product is implemented/used.
- Exclusively use Hengst products in technically perfect condition.
- Observe all notices on the product.
- Persons assembling, operating, disassembling or maintaining Hengst products must not be under the influence of alcohol, other drugs or medications influencing the ability to react.
- Only use accessories and spare parts approved of by the manufacturer in order to exclude hazards to persons due to unsuitable spare parts.
- Comply with the technical data and environmental conditions indicated in the product documentation.
- The installation or use of inappropriate products in safety-relevant applications could result in unintended operating conditions when being used which in turn could cause personal injuries and/or damage to property. Therefore, only use a product for safety-relevant applications if this use is expressly specified and permitted in the documentation of the product, e.g. in explosion-protected areas or in safety-related parts of control systems (functional safety).

2.6 Product-specific safety instructions

The following safety instructions apply to chapters 6 to 14.

WARNING

High electrical voltage!

Danger to life, risk of injury caused by electric shock or severe injury!

- ▶ Never cut, damage or modify the connection cables and never put any objects on them.
- ▶ Never touch the online particle monitor with wet or humid hands.
- ▶ Only connect the online particle monitor to power sources for which it is suitable, see chapter 14 "Technical data".
- ▶ During thunderstorms pull the power cable out of the socket.
- ▶ Pull the power cable out of the socket in case of odor or smoke development or if the cable is damaged.
- ▶ Ensure that your system is properly earthed. Faulty earthing may lead to incorrect measurements.

CAUTION

Contact with laser beam!

Risk of injury! Risk of burning for eye and skin!

- ▶ Do not remove any cover or casing at the online particle monitor.
- ▶ Have repair works at the online particle monitor only be carried out by trained service personnel.

Hot surfaces at the online particle monitor!

Risk of injury! Risk of burning!

- ▶ Only touch oil-containing surfaces with protective gloves or do not work at hot surfaces.
- ▶ During or after the operation, temperatures may rise to values higher than 60 °C (140 °F), depending on the operating conditions.
- ▶ Allow the online particle monitor to cool down sufficiently before touching it.

Hydraulic fluid leaking at the online particle monitor in an uncontrolled form!

Risk of burning! Risk of injury! Risk of fire!

- ▶ Switch off the online particle monitor immediately.
- ▶ Identify and remedy the cause of the leakage.
- ▶ Never try to stop or seal the leakage or the oil jet using a cloth.
- ▶ Avoid direct contact with the leaking oil jet. The oil might be under high pressure.
- ▶ Carry out visual inspections for leak-tightness of the online particle monitor on a regular basis.

CAUTION

Slip hazard due to oily surfaces!

Risk of injury!

- ▶ Protect and mark the danger zone.
- ▶ Immediately remove leaked hydraulic fluid.
- ▶ Use an oil binding agent in order to bind the leaked hydraulic fluid.
- ▶ Remove and dispose of the contaminated oil binding agent, see chapter 11 "Disposal".
- ▶ Wear the protective equipment prescribed for your activity like e.g. gloves, safety shoes.

2.7 Warning and information signs at the product

On the back side of the device, there is an information sign specifying the laser class according to DIN EN 60825-1.



Fig. 1: "Laser class" information sign

At the device side/at the circumference, the warning sign for laser radiation has been attached.



Fig. 2: "Laser radiation" warning sign

3 General information on damage to property and damage to the product

NOTICE

Danger due to improper handling!

Damage to property!

- ▶ The online particle monitor may only be operated according to chapter 2.2 "Intended use".
- ▶ Never expose the online particle monitor to excessive heat or humidity. In this connection observe the values specified in chapter 14 "Technical data".
- ▶ Never immerse the online particle monitor into water or other liquids.
- ▶ Never allow liquids to penetrate the device.
- ▶ Do not use the online particle monitor after it has been dropped.

Leaking or spilt hydraulic fluid!

Environmental pollution and pollution of the ground water!

- ▶ Use an oil binding agent in order to bind the leaked hydraulic fluid.
- ▶ Immediately remedy possible leakage.
- ▶ Observe the information in the safety data sheet of the hydraulic fluid and the system manufacturer's specifications.
- ▶ Dispose of the hydraulic fluid in accordance with the currently applicable national regulations in your country.

Contamination by fluids and foreign particles!

Early wear, malfunctions! Risk of damage! Damage to property!

- ▶ During assembly and disassembly of the online particle monitor, provide for cleanliness in order to prevent foreign particles like e.g. welding beads or metal chips from getting into the hydraulic lines and causing product wear or malfunctions.
- ▶ Ensure that all connections and hydraulic lines are free of dirt and free of chips.
- ▶ Check before commissioning whether all hydraulic and mechanical connections are connected and tight and that all the seals and caps of the plug-in connections are correctly installed and undamaged.
- ▶ For removing lubricants or any other contamination, use industrial residue-free wipes.
- ▶ Only complete cleaning processes at the online particle monitor if the hydraulic connections are closed.
- ▶ When sealing the connections, make sure that no contamination can get into the system.

4 Scope of delivery

The scope of delivery includes:

- 1 x online particle monitor OPM II
- Accessories (can be optionally ordered depending on the application)
- 1 x operating instructions



More information on the accessories for the online particle monitor is contained in data sheet 51460, see chapter 1.2 "Required and amending documentation".

5 Information on this product

5.1 Performance description

5.1.1 General information

The online particle monitor comprises a laser sensor which - if used as intended - is classified as "Class 1 product" according to 21CFR, sub-chapter J, of the Health and Safety Act 1998.

Connection to the fluid-transporting system is effected by means of two threaded couplings for screw connection M16 x 2.

5.1.2 Measuring principle

The OPM II is a visual particle monitor that operates on the light-extinction principle.

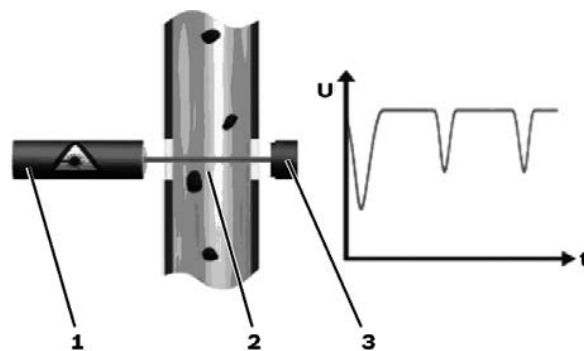

Fig. 3: Set-up and measuring principle of a particle monitor

- 1 Laser
- 2 Measuring cell
- 3 Photo diode

The laser (1) radiates through the measuring cell (2) and hits the photo diode (3). If a particle / foreign particle passes through the laser beam, the intensity detected by the photo diode is reduced. The larger the particle / foreign particle, the more is the intensity reduced.

5.1.3 Display of the measured values

The measured values are converted in cleanliness classes according to ISO4406:99 or SAE AS4059E and indicated on the display in case of operation of the online particle monitor as standalone device.

The measured data can also be read out and transmitted to a control system via CAN bus.

Another possibility is the transmission of the measured data to a PC via a USB CAN adapter by means of a cable and its analysis via special software.

5.1.4 Description of the functions

Cleanliness monitoring Using the online particle monitor, the level of contamination and the purity trend of fluids can be monitored. In this connection, differences as compared to particle monitors calibrated according to ISO 11171:99 may occur with regard to the absolute accuracy. The difference is, however, smaller than an ordinal number. Changes are displayed in a very precise manner.

Due to the permanent monitoring of the purity, changes in the machine can be detected very quickly. Due to the fast warning, measures can be taken without any further serious contamination and thus possible damaging of the entire system.



Depending on the application conditions, Hengst recommends calibration every two years.

Temperature monitoring The online particle monitor also measures the temperature. It is not measured in the oil but on the electronic circuit board.

Operating hours display The online particle monitor has an operating hours counter the values of which are also available after current interruptions. After the interruption, the counter re-starts counting at the last stored time value before the interruption.

5.2 Component overview



Fig. 4: Component overview

- | | |
|-----------------------------------|--------------------------------|
| 1 Fluid supply | 7 ENTER key |
| 2 Device front (rotatable) | 8 DOWN key |
| 3 POWER indicator light | 9 Electrical connection |
| 4 ALARM indicator light | 10 UP key |
| 5 Display | 11 ESCAPE key |
| 6 Fluid discharge | |

- Fluid supply (1)** The online particle monitor is equipped with two threaded couplings for screw connection M16x2. Two hose lines are usually connected here by means of which the online particle monitor is connected to the fluid-containing system.
- Fluid discharge (6)**
- Device front (rotatable) (2)** The front side of the online particle monitor can be rotated by approx. 190° so that irrespective of the assembly, the display can always be positioned horizontally.
- Display (5)** The SW display shows the last determined cleanliness classes as well as the time until the next measurement and/or the remaining time of the measurement.
- POWER indicator light (3)** If operating voltage is available, this display is illuminated in green.

ALARM indicator light (4) If an alarm is pending, this display is illuminated in red.
In the online particle monitor, two alarms can be programmed; in this connection see chapter 9.3.2 "Configuring alarms".

Electrical connection (9) This connection is used to plug in the plug-in power supply unit, the control cable or the Y distributor. The Y distributor is necessary if a plug-in power supply unit and an USB CAN adapter are to be connected at the same time.





More information on the accessories for the online particle monitor is contained in data sheet 51460, see chapter 1.2 "Required and amending documentation".

The following keys are used for the entire operation and programming within the menus shown in the display:

ENTER key  (7) Using this key, you can select menu entries, open submenus, confirm entries and go to the next figure in an entry field.

DOWN key  (8) Using this key, you can call the main menu from the measured value display, move the marking downwards and reduce a figure in an entry field.

UP key  (10) Using this key, you can call the main menu from the measured value display, move the marking upwards and increase a figure in an entry field.

ESCAPE key  (11) Using this key, you can move one menu level up, quit the main menu and cancel the entry.

5.3 Product identification

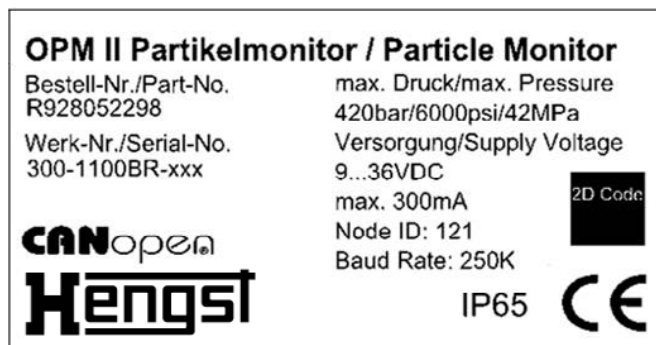

Fig. 5: Name plate

6 Transport and storage

- ▶ For storing and transporting the product always observe the environmental condition specified in the technical data, see chapter 14 "Technical data".

6.1 Transporting the online particle monitor

- ▶ Ensure during transportation that the online particle monitor does not fall down.
- ▶ Do not use the online particle monitor after it has been dropped or if the housing is damaged.

6.2 Storing the online particle monitor

- ▶ Store the online particle monitor in a frost-free room, in a dry and dust-free environment.
- ▶ Drain the hydraulic fluid before storage and dispose of it according to chapter 11.1 "Environmental protection".

7 Assembly

7.1 Unpacking the online particle monitor

- ▶ Remove the packaging.
- ▶ Dispose of the packaging in accordance with the currently applicable national provisions in your country.
- ▶ When unpacking it, look out for damage at the online particle monitor.
- ▶ Do not use a damaged online particle monitor.

7.2 Installation conditions

7.2.1 Space required

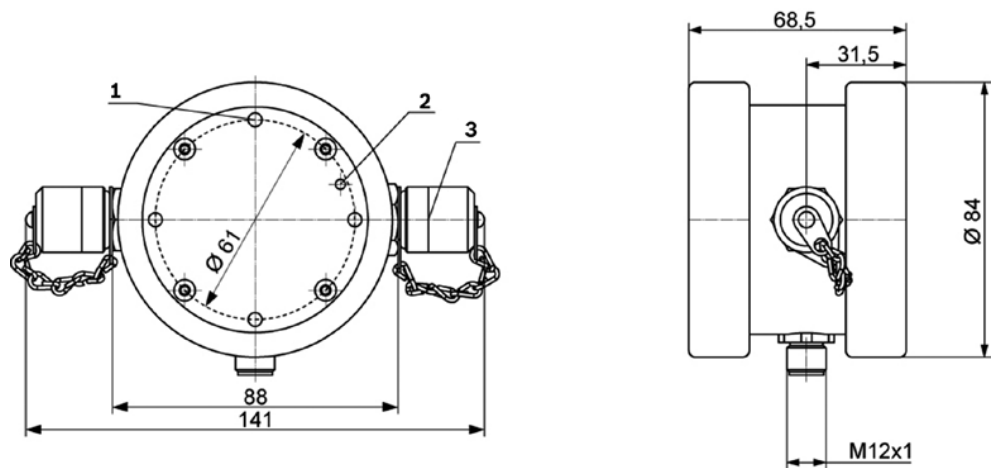

Fig. 6: Dimensions

- 1 Four mounting points M5 x 5.5
- 2 Bleeding opening with pressure compensation element (fastened from the inside)
- 3 2 x threaded coupling for screw connection M16 x 2

7.2.2 Installation position

Please observe this information when determining the place of installation:

- ▶ Connect the online particle monitor to a pressure line using the T branch in the bypass.
The flow direction is irrelevant.
- ▶ Make sure that at the connection point, the pressure conditions are as constant as possible.
The pressure may vary, there must, however not be any pressure peaks or strong fluctuations.
- ▶ Make sure that the flow is constant and the value lies between 50 ... 400 ml/min.

- ▶ Ensure that the flow control or pressure reduction unit is installed downstream the online particle monitor as such equipment may create particles or air bubbles leading to measuring errors.
- ▶ If a pump is necessary to create the required flow, make sure that it is of low-pulsation design.

Otherwise, bubbles might be created in case of arrangement on the suction side leading to measuring errors.

7.3 Assembling the online particle monitor

7.3.1 Hydraulically connecting the online particle monitor

WARNING

Pressurized device!

Danger to life, risk of injury, severe injury when working at systems that have not been stopped! Damage to property!

- ▶ Do not disconnect lines, connections or components as long as the online particle monitor is pressurized.

Special information regarding the hydraulic connection of the online particle monitor

- ▶ Ensure during assembly that afterwards, the display will be easily readable. For simplification, the display can be rotated by approx. 190°.
- ▶ Keep the connection lines as short as possible.

With the length of the line, the risk of settlement of larger particles increases.

- ▶ Ensure particularly with higher viscosities and when using hose lines that the pressure is high enough in order to set a flow between 50 ... 400 ml/min.
- ▶ Make sure that the measured hydraulic fluid is free from bubbles and drops.

Bubbles and droplets in the hydraulic fluid can mostly be identified from very high ordinal numbers and/or identical ordinal numbers in different size channels. Such bubbles and droplets are hardly visible to the naked eye.

Estimation of the required pressure level

Observe the ΔP of the online particle monitor dependent on the viscosity of the hydraulic fluid.

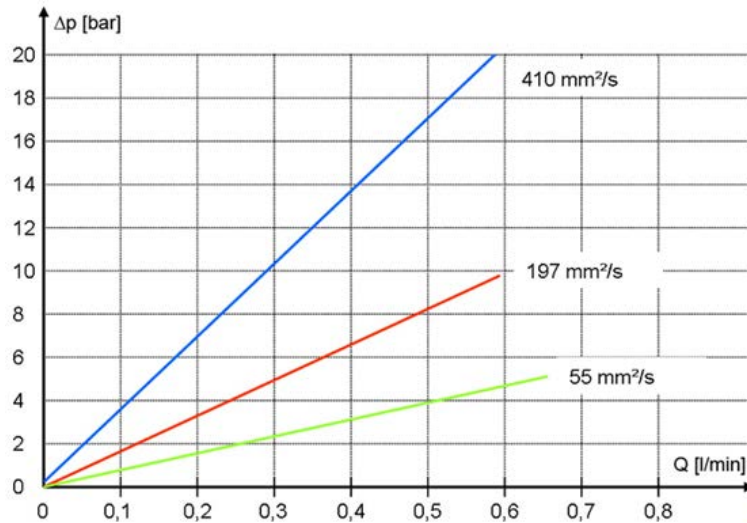

Fig. 7: Δp -Q characteristic curve for different viscosities

Based on this, you can estimate the required pressure level for the required flow of 50 ... 400 ml/min.

- Procedure**
- ▶ Identify a place of installation complying with the criteria specified under chapter 7.2.2 "Installation position".
 - ▶ Depressurize the system.
 - ▶ Connect two fluid lines to the two threaded couplings.
 - ▶ Fasten the online particle monitor using the mounting points, see fig. 6: Dimensions, on the device back side.

7.3.2 Electrically connecting the online particle monitor

! WARNING

Faulty energy supply!

Danger to life! Risk of injury!

- ▶ Always observe country-specific regulations.

- ▶ Design the voltage supply according to EN50178, SELV, PELV, VDE0100-410/A1.
- ▶ Use the Y distributor if a plug-in power supply unit and an USB CAN adapter are to be connected at the same time.



More information on the accessories for the online particle monitor is contained in data sheet 51460, see chapter 1.2 "Required and amending documentation".

- ▶ De-energize the system for the installation and connect the online particle monitor as described in the following.

Pin assignment of the electrical connection (sensor connection)



Fig. 8: Pin assignment (top view to the sensor cover)

1 +U _B	5 Digital input
2 GND	6 IOUT1
3 TxD; CAN-L	7 Open collector, alarm OUT
4 RxD; CAN-H	8 SGND

The admissible operating voltage lies between 9 ... 36 VDC. Use only shielded sensor cables. In order to achieve protection class IP 67, only suitable connectors and cables may be used. The maximum tightening torque for the connector is 0.1 Nm.

Analog current outputs (4 ... 20 mA) – Measurement without load resistance

► Carry out the current measurement using a suitable measuring device.

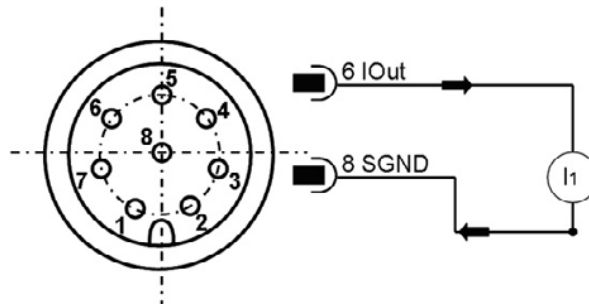

Fig. 9: Measurement of the analog current outputs 4 ... 20 mA output without load resistance

The ordinal number is calculated from the current I_1 and the formula in chapter 7.5 "Calibration".

Analog current outputs (4 ... 20 mA) – Measurement with load resistance

In order to be able to measure the currents of the two analog current outputs, a load resistance must be connected to every output - as shown below.

Depending on the supply voltage, the load resistance should lie between 250 and 2600 Ω .

The load resistance is defined according to the "Determination of the required load resistance" (see below).

Using a voltmeter, you can now measure the voltage decreasing over the resistance.

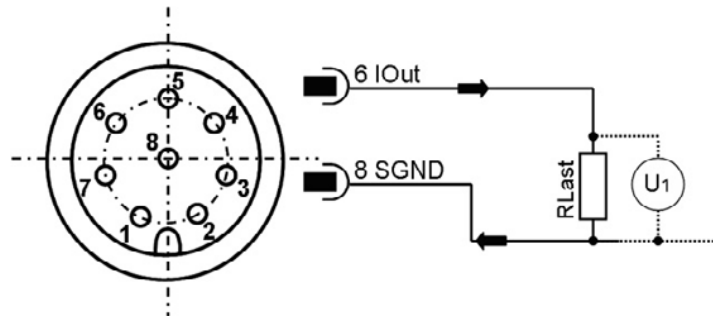

Fig. 10: Measurement of the analog current outputs 4 ... 20 mA output with load resistance

Digital input

The digital input is *HIGH – active*. It is active as soon as there is supply voltage and *floats* when there is no voltage.

A measurement lasts as long as the digital input is NOT connected to ground.

If the input is connected to ground, there is a current of

$$I = (U - 1.1 \text{ V}) / 5,600 \Omega$$

With U = supply voltage.

Determination of the required load resistance

The load resistance cannot be arbitrarily selected. It must be adjusted according to the sensor supply voltage.

The maximum load resistance can be calculated using the following formula or determined from the table next to it:

Table 5: Determination of the load resistance

Formula	$U_{\text{(supply)}}$ [V]	R_{max} [Ω]
$R_{\text{max}} = \frac{U - 2V}{20\text{mA}} - 100\Omega$	9	250
	12	400
	18	600
	24	1000
	30	1300

7.4 Switching output

The switching output is not short-circuit-proof and does not have any over-current- or overtemperature fuse. Die maximum switching voltage is 36 VDC.

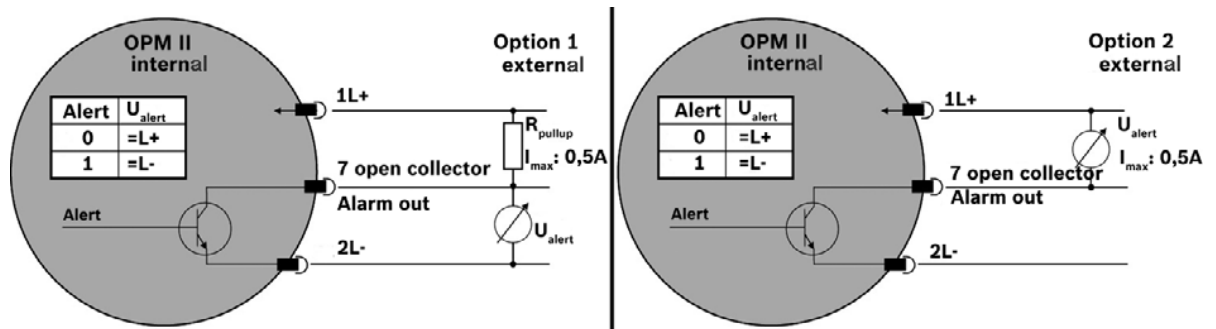

Fig. 11: Switching output

Option 1		Option 2	
Internal	External	Internal	External
Alert	U _{alert}	Alert	U _{alert}
0	=U+	0	=0
1	=0	1	= U+

7.5 Conversion of analog current output to atomic number

The analog current output provides a signal from 4 ... 20 mA. The conversions for the respective atomic numbers are described below.

Table 6: Comparison table current output to atomic number ISO and SAE

I/mA	ISO 4406:99	SAE AS4059E
4	0	000
12	13	5
20	26	12

Table 7: Comparison table current output to atomic number NAS and GOST

I/mA	NAS 1638	GOST 17216
4	00	00
12	7	15
13	8	17
14	9	-
15	10	-
16	11	-
17	12	-
20	-	-

Table 8: Conversion of atomic numbers

Standard	Atomic number formula
ISO 4406:99	1,625 * I/mA - 6.5
SAE AS4059E	0,875 * I/mA - 5.5
NAS 1638	I/mA - 5
GOST 17216	2 * I/mA - 9

7.6 Sequential data output

For the standards ISO 4406:99 and SAE AS4059E, you can select a sequential data output.

There are two modes for the sequential data output:

- Sequential
- Sequenziell2

7.6.1 Sequential

After a start sequence (S), the measurement values for the different size classes are transmitted one after another. After a pause, the next cycle begins with the transmission of the start sequence.

For NAS and GOST, no sequential output is available.

Sequence 1 - 5

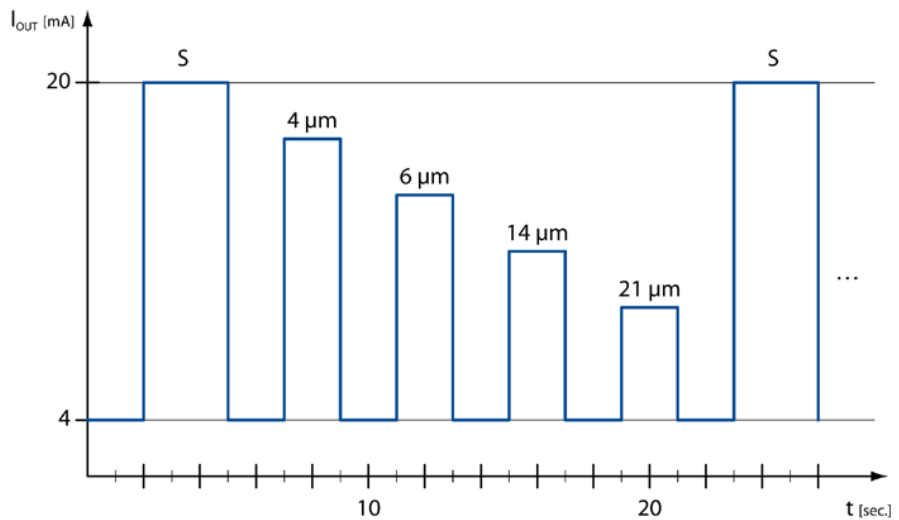

Fig. 12: Sequence for the output of all parameters one after another

7.6.2 Sequenziell2

The „Sequenziell2“ mode is an expansion of the „Sequenziell“ mode. The expansion consists of the three following sequences:

Sequence 6

	I/mA							
Meaning	5	7	9	11	13	15	17	19
Flow too low ERC 1, Bit 10	1	1	1	1	0	0	0	0
Flow too high ERC 1, Bit 9	1	1	0	0	1	1	0	0
Error in measurement cell ERC 4, Bit 0, 1, 2 or 3	1	0	1	0	1	0	1	0

Sequence 7

	I/mA							
Meaning	5	7	9	11	13	15	17	19
Concentration too low ERC 1, Bit 14	1	1	1	1	0	0	0	0
Concentration too high ERC 1, Bit 8	1	1	0	0	1	1	0	0
Measurement result not plausible ERC 1, Bit 13	1	0	1	0	1	0	1	0

Sequence 8

Meaning	I/mA							
	5	7	9	11	13	15	17	19
Alarm concentration ERC 4, Bit 14	1	1	1	1	0	0	0	0
Alarm temperature ERC 4, Bit 15	1	1	0	0	1	1	0	0
ISO(i+1) ≥ ISO(i) ERC 1, Bit 11	1	0	1	0	1	0	1	0

List of all ERCs: Error Code see chapter 13.3. „Error code“

8 Commissioning

After the electric and hydraulic connection, the online particle monitor will immediately start with the measurements and indicate the first measurement results on the display after one minute.

9 Operation

9.1 Operating concept

- ▶ Here's how the operating keys are programmed:



Calls up the main menu from the measurement value display
Moves the highlighting up
Increases a number in an input field



Calls up the main menu from the measurement value display
Moves the highlighting down
Reduces a number in an input field



Selects menu entries from and open submenus
Confirms the entries
Jumps to the next number in an input field



Jumps one menu level up
Exits the main menu
Cancels entries

9.2 Menu structure

Fig. 13: Menu structure

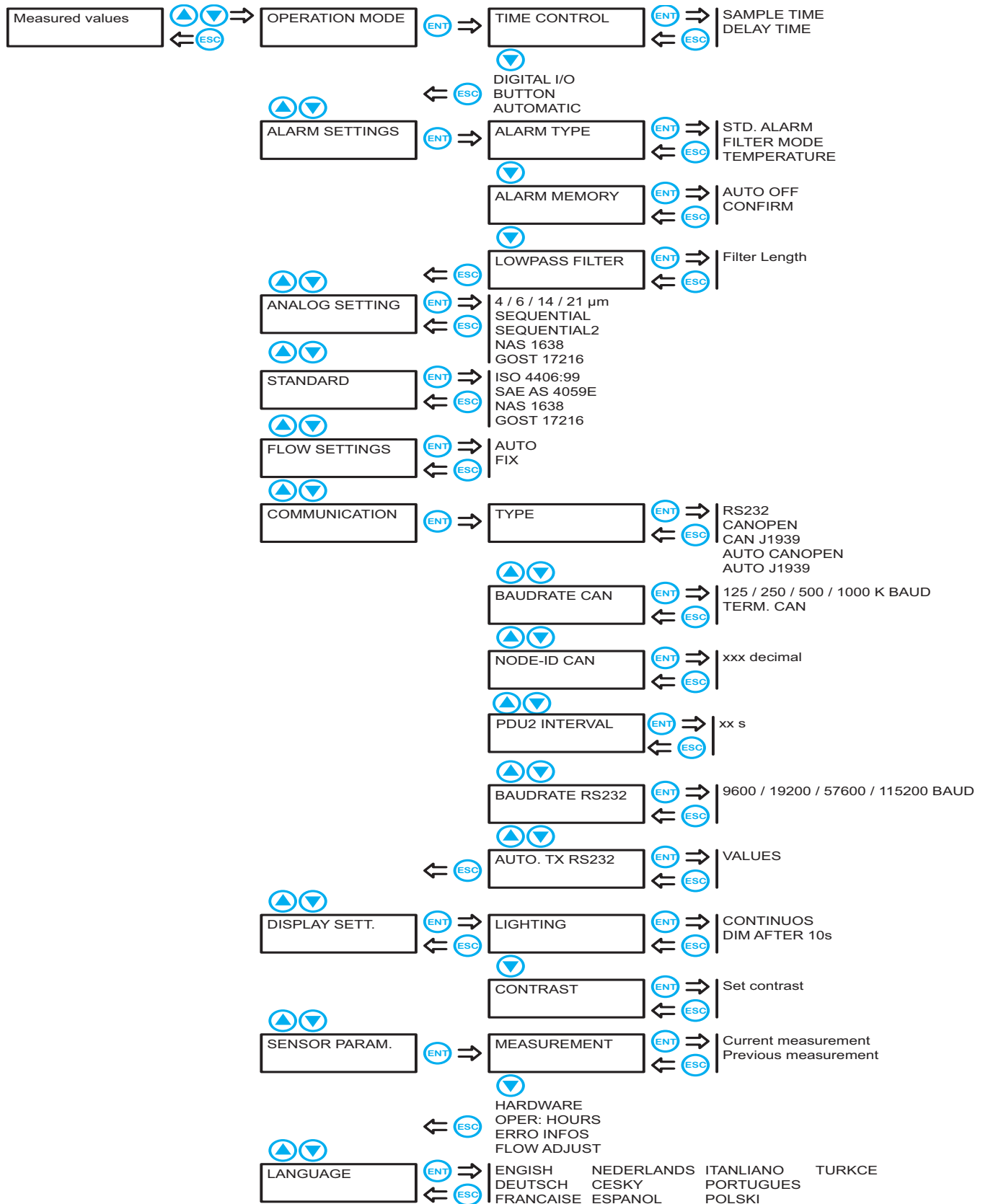

9.3 Operation

9.3.1 Operating modes



You should comply with a minimum measurement duration of 30 seconds as otherwise, it might not be possible to completely detect the number of particles. The cleaner the hydraulic fluid, the longer the measurement should take. Degrees of cleanliness according to ISO 4406:99 of 15 and better should at least be re-measured every 120 seconds.

Three operating modes are available which can be set by means of entries in the menu:







Time control The online particle monitor works with the set measurement duration and waiting times between the measurements.

Example:

One minute measurement duration and four minutes waiting time will yield a result every five minutes. Actually, however, it takes about two to three seconds longer as the laser will be adjusted at the beginning of every measurement.

- ▶ With activated and marked "Time control" option, press  once again in order to set measurement duration and waiting time.

Proceed as follows to set the measurement duration:

- ▶ Press  to start the entry.
- Arrows appear at the first figure.
- ▶ Press   in order to set the first figure.
- ▶ Press  to change to the next figure.
- ▶ Set all figures of the measurement duration in this way.
- ▶ Confirm your entry with  and press .

Proceed as follows to set the waiting time:

- ▶ Set the desired waiting time as described for the measurement duration.

Digital I/O The digital input is active if it is connected to the ground (low-active). A measurement is started when the digital input becomes inactive. It is terminated as soon as the digital input is activated. If the input is active, a current of $I = (U - 1.1 \text{ V}) / 5,600 \Omega$ with $U =$ supply voltage will be set.

- Key**
- ▶ Press  in order to start and terminate a measurement.

Automatic In automatic mode, the measurement time is determined dynamically, depending on the flow and the particle concentration. The measurement can last between 45 and 300 seconds. A measurement value should be awaited at the earliest after 45 seconds if in this time the defined number of particles was detected. If the defined number of particles has also not been detected after 300 seconds, the measurement is cancelled and the result displayed. The result is then not backed up statistically.

9.3.2 Configuring alarms

Alarm type Here, you can first of all select the alarm type:

Std. alarm

As soon as a channel exceeds a set alarm threshold, the alarm will be triggered.

Filter mode



The filter mode is used to monitor the cleaning. As soon as the value of all activated channels has fallen below a threshold, the alarm will be triggered.

Temperature

As soon as the temperature exceeds the set threshold, the alarm is triggered.

In order to deactivate the alarm, the limit value must be "00".

The measured temperature does not correspond directly to the temperature of the oil.

- ▶ Activate the desired alarm type by means of  and press  once again in order to display the alarm thresholds:

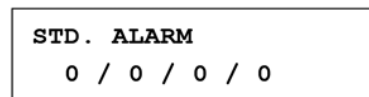





Fig. 14: Alarm type

- ▶ Press  to start the entry. Arrows appear at the first "Zero".
- ▶ Press   in order to set the first alarm threshold.
- ▶ Press  to change to the next size class.
- ▶ Set the alarm thresholds for all size classes in this way. If one of the alarm thresholds is not to be considered, set its value to "Zero".



With alarm threshold 0/0/0/0, no alarm will be issued. The function is deactivated. With the measured value 0/0/0/0, the current alarm condition is maintained. The switching of the alarm is signaled by the red LED and an exclamation mark on the LCD.

The alarm thresholds set for the standard alarm also apply to the filter mode and vice versa.

Alarm memory Here, you select the behavior of the online particle monitor in case of an alarm. It can either be switched off automatically ("Autom. off" setting) or remain active until acknowledgment by means of the push of a button ("Confirmation").

Low pass filter In a hydraulic system, short-term concentration increases (peaks) can occur, which are not representative for the overall system. The particle counter detects this change and displays these correctly.

The deep-pass filter ensure that for a set alarm threshold, an alarm is not triggered for each peak. The particle concentrations relevant for the alarm are smoothed internally and an alarm is only output in case of a long-lasting measurement change. The measurement value output and display are not affected by the filtering.

- ▶ With a volumetric flow of 0 ml/min or an ISO class of 0 to 4 µm, the filter function is deactivated automatically.
- ▶ Adjustment range: 1 ... 255 (1 = deactivated)
- ▶ Factory setting: 2
- ▶ Recommended value: ≤10

9.3.3 Configuring the analog output

Here you can select which data is to be output via the analog output:

- 4 / 6 / 14 / 21** ▶ Select a size class the measured value of which is to be output via the analog output.
- The output is linear, in whole ordinal numbers (4 mA corresponds to the ordinal number "Zero", 20 mA to the ordinal number "26").
The output depends on the set standard, ISO or SAE.
The maximum load depends on the supply voltage ($R_{max} = ((U - 2 V) / 20 \text{ mA}) - 100 \Omega$).
- Sequential** The measured values of all size classes are output one after the other, see chapter 7.6 "Sequential data output".
- Sequenziell2** The measurement values of all size classes are output one after another. Alarms are also output, see chapter 7.6 "Sequential data output".
- NAS 1638** Output regardless of set standard. On the LCD, ISO, SAE or GOST can be displayed; however, via the analog output, NAS is output.
- GOST 17216** Output regardless of set standard. On the LCD, ISO, SAE or NAS can be displayed; however, via the analog output, GOST is output.

9.3.4 Selecting the standard

- ▶ The display of the purity can be selected according to one of the following standards:
 - ISO 4406:99
 - SAE AS4059E
 - NAS 1638
 - GOST 17216
- ▶ For the display according to SAE, ensure that the size classes 38 and 70 µm are not evaluated on separate channels, but together with the size class 21.
- ▶ The setting refers only to the display on the start screen. In the internal memory and for the output via the digital interface (CAN or RS232), all standards are visible.
- ▶ You can tell which standard is selected in the bottom left of the start screen.

9.3.5 Configuring the flow

In addition to particle size and quantity, the online particle monitor also detects the flow in order to calculate the concentration therefrom. This is done if the "Auto" option is set (recommended flow: 100 ... 400 ml/min).

However, as there are inaccuracies with every measurement, you can fixedly set a known flow. The latter is then used to calculate the concentration.

- ▶ Set the "Fix" option and press  once again:

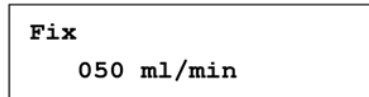





Fig. 15: Configuring the flow

- ▶ Press  to start the entry.
Arrows appear at the first digit.
- ▶ Press   in order to set the first figure.
- ▶ Press  to change to the next figure.
- ▶ Set the flow in this way.

Select a flow rate that is similar to the actual flow rate. In case of a larger deviation, the calculated concentration is falsified.

9.3.6 Selecting the communication

Here you can define the configuration of the digital interface.

Interface type selection

RS 232	Data output via the RS 232 interface.
CANopen	Output of the data via CAN bus in the CANopen protocol.
CAN J1939	Output of the data via CAN bus in the J1939 protocol.
Auto CANOPEN ^(a)	The connected interfaces are detected automatically. If the CAN type is detected, the CANopen protocol is used.
Auto J1939 ^(a)	The connected interfaces are detected automatically. If the CAN type is detected, the CAN J1939 protocol is used.

(a) For the type **Auto** the type is determined using the physical voltage level on the digital interface. The determination is done once when switching the particle counter on.

- Baud rate CAN** ▶ Select the data transmission speed of the CAN interface.



The selected speed must comply with that of your CAN bus; otherwise, no communication will be possible.

- | | |
|----------------|---|
| 50 / 125 / ... | ▶ Select the speed in kBaud. |
| Term. CAN | Connects a 120 Ω resistance to terminate the CAN strand. This option should always be activated. |

- Node ID CAN** Here you can display the set node ID of the online particle monitor. You need it in order to address CAN commands correctly and/or to assign CAN signals correctly.

PDU2 Interval You can set the interval with which the PDU2 is sent here. PDU2 is only used with CAN J1939.

Baud rate RS 232 ▶ Select the data transmission speed of the RS 232 interface.



The selected speed must comply with that of your system; otherwise, no communication will be possible.

Automatic send Here, you can set whether the measurement values are sent automatically via the RS232 interface.



9.3.7 Configuring the display

The display illumination will by default go out after ten seconds ("Dimming 10 s"). You can, however, also switch it on permanently ("Continuously").

9.3.8 Sensor parameters

In this menu item, you can display different parameters of the online particle monitor:

Measurement results Here, the last measurement results of the size classes as well as the index of the volume flow are shown.

- ▶ Press  to switch the display between the size classes.
- ▶ Press  to display the previous measurement result.

Electronics Here, the different measured values of the electronics are displayed.

- ▶ Press  to display more parameters.

Operating hours Here, the number of operating hours of sensor and laser is shown.

Error information Here, a list of the occurred error messages and alarms is displayed.

- ▶ Press   to scroll through the available messages.

Set flow Here, the level of the volumetric flow is displayed.

- If the bar is between "L" and "H", the volumetric flow is OK.
- If the bar fills the entire diagram or if no bar is visible and "H/L" is flashing, the volumetric flow is too high or too low and has to be adjusted.

The limits of the display (bar diagram) are between L = 50 ml/min and H = 400 ml/min.

The display is updated every 10 seconds.

If the "FIX" flow is set to a static value, this is also displayed. However, the bar will not change.

9.3.9 Setting the language

- ▶ Select one of the available languages for the display of the operating menu.

9.4 Communication interfaces

9.4.1 Configuration of the serial interface

The online particle monitor can be read out and configured via a serial interface. For this purpose, you need a PC with an installed terminal software.

Connect the online particle monitor to a free COM port of the computer. A suitable communication cable for the serial connection between sensor and PC/control is available as accessory.

If the computer does not have a COM port by default, there is the possibility to use a serial interface card or a USB serial converter.

Interface parameters

- Baud rate: 9600 / 57600
- Data bits: 8
- Parity: None
- Stop bits: 1
- Flow control: None

List of read commands

Table 9: Read commands

Command	Meaning	Return format
RVal[+]	Reading of the current measured values with subsequent checksum (CRC)	\$Time:%.4f[h];ISO4µm:%i[-];ISO6µm:%i[-];ISO14µm:%i[-];ISO21µm:%i[-];SAE4µm:%i[-];SAE6µm:%i[-];SAE14µm:%i[-];SAE21µm:%i[-];Conc4µm:%.2f[p/ml];Conc6µm:%.2f[p/ml];Conc14µm:%.2f[p/ml];Conc21µm:%.2f[p/ml]; FIndex:%i[-]; MTime:%i[s];Status:0x0000; 0x0000;0x0000;0x0000;CRCx
RMemS[CR]	Reading of the number of datasets that can be stored	MemS:xxxx[CR][LF]
RMemU[CR]	Reading of the number of stored datasets	MemU:xxxx[CR][LF]
RMem[+]	Reading of all stored measured values	Time [h]; T [°C]; P [-];P40 [-];PTG [1/K];...[CR][LF] x,xxx;x,xxx;x,xxx;x,xxx; x,xxx; ...[CR][LF]
RID[+]	Reading of the identification with subsequent checksum (CRC)	Hydro-technology;Patrick;SNxxxxx-xxx; SW:xx.xx,xx;CRCx 1)
RCon[+]	Reading of the current configuration	Smode:%i;Fmode:%i;Analog:%i;Amode:%i;Alarm4:%i;Alarm6:%i;Alarm14:%i;Alarm21 :%i;(Mtime:%i[s]; Htime:%i[s])

9.4.2 Communication via USB

The online particle monitor can be read out via a USB interface.

For this purpose, you need a PC with the installed OPM II - Professional software.



Observe the notices in the online help of the OPM II - Professional software for more information.

- Connect the online particle monitor to a USB interfaces of the computer.

The USB-CAN adapter with cable is available as accessory.



More information on the accessories for the online particle monitor is contained in data sheet 51460, see chapter 1.2 "Required and amending documentation".

9.4.3 CANopen

The online particle monitor can be integrated into bus systems corresponding to the CANopen standard.

For a detailed description of CANopen and the underlying architecture please refer to different reference and textbooks.

CANopen Object Dictionary

The following table contains the communication-related part of the object directory of the online particle monitor.

Except for few exceptions, the possible settings correspond to the CANopen standard as it is described in "DS-301".

Table 10: Communication-related part of the object directory

Communication profile						
Idx	SIdx	Name	Type	Attr.	Standard	Comments
1000h	0	Device type	unsigned 32	ro	194h	Sensor, see DS404
1001h	0	Error list	unsigned 8	ro	00h	Obligatory, see DS301
1017h	0	Heartbeat time	unsigned 16	rw	1388h	Heartbeat time in ms, range: 0 ... 65535
1018h		Identity object	record	ro		
	0	Number of entries	unsigned 8	ro	04h	Largest sub-index
	1	Manufacturer ID	unsigned 32	ro	000001C0h	000001C0h
	2	Product code	unsigned 32	ro	12D5C74Ch	12D5C74Ch
	3	Version number	unsigned 32	ro	1000	Device-dependent
	4	Serial number	unsigned 32	ro		Device-dependent
1800h		Transmission of PDO1 parameters	record			
	0	Number of entries	unsigned 8	ro	05h	Largest sub-index
	1	COB-ID	unsigned 32	rw	180h +NodeID	COB-ID of PDO used, range: 181h ... 1FFh, can be changed when switched off (bit 30 must always be set, means no TPDO triggered to RTR)
	2	Transmission type	unsigned 8	rw	FFh	Cyclic + synchronous, asynchronous; Values: 1 ... 240, 254, 255
	5	Event time measurement	unsigned 16	rw	1F4h	Event time in ms for asynchronous TPDO1, value must be a multiple of 50 and max. 12700
1801h		Transmission of PDO2 parameters	record			
	0	Number of entries	unsigned 8	ro	05h	Largest sub-index
	1	COB-ID	unsigned 32	rw	280h +NodeID	COB-ID of PDO used, range: 281h ... 2FFh, can be changed when switched off (bit 30 must always be set, means no TPDO triggered to RTR)
	2	Transmission type	unsigned 8	rw	FFh	Cyclic + synchronous, asynchronous; Values: 1 ... 240, 254, 255
	5	Event time measurement	unsigned 16	rw	1F4h	Event time in ms for asynchronous TPDO2 Range: 0 ... 65000
1802h		Transmission of PDO3 parameters	record			
	0	Number of entries	unsigned 8	ro	05h	Largest sub-index
	1	COB-ID	unsigned 32	rw	380h +NodeID	COB-ID used by PDO, range: 381h ... 3FFh, can be changed when switched off (but 30 must always be set, means no TPDO triggered to RTR)
	2	Transmission type	unsigned 8	rw	FFh	Cyclic + synchronous, asynchronous; Values: 1 ... 240, 254, 255
	5	Event time measurement	unsigned 16	rw	1F4h	Event time in ms for asynchronous TPDO3 Range: 0 ... 65000

Communication profile						
Idx	SIdx	Name	Type	Attr.	Standard	Comments
1A00h		TPD01 mapping parameters	record			
	0	Number of entries	unsigned 8	ro	05h	Largest sub-index
	1	PDO mapping for first application object to be mapped	unsigned 32	co	20000220h	Operating hour time stamp of the measurement, 4 byte
	2	PDO mapping for second application object to be mapped	unsigned 32	co	20010108h	ISO 4 μm , 1 byte in 2001h, sub 01
	3	PDO mapping for third application object to be mapped	unsigned 32	co	20010208h	ISO 6 μm , 1 byte in 2001h, sub 02
	4	PDO mapping for fourth application object to be mapped	unsigned 33	co	20010308h	ISO 14 μm , 1 byte in 2001h, sub 03
	5	PDO mapping for fifth application object to be mapped	unsigned 32	co	20010408h	ISO 21 μm , 1 byte in 2001h, sub 04
1A01h		TPD02 mapping parameters	record			
	0	Number of entries	unsigned 8	ro	05h	Largest sub-index
	1	PDO mapping for first application object to be mapped	unsigned 32	co	20000220h	Operating hour time stamp of the measurement, 4 byte
	2	PDO mapping for second application object to be mapped	unsigned 32	co	20020108h	SAE 4 μm , 1 byte in 2002h, sub 01
	3	PDO mapping for third application object to be mapped	unsigned 32	co	20020208h	SAE 6 μm , 1 byte in 2002h, sub 02
	4	PDO mapping for fourth application object to be mapped	unsigned 33	co	20020308h	SAE 14 μm , 1 byte in 2002h, sub 03
	5	PDO mapping for fifth application object to be mapped	unsigned 32	co	20020408h	SAE 21 μm , 1 byte in 2002h, sub 04
1A02h		TPD03 mapping parameters	record			
	0	Number of entries	unsigned 8	ro	05h	Largest sub-index
	1	PDO mapping for first application object to be mapped	unsigned 32	co	20000120h	Operating hours counter, 4 byte
	2	PDO mapping for second application object to be mapped	unsigned 32	co	20030108h	Oil state bits, 1 byte
	3	PDO mapping for third application object to be mapped	unsigned 32	co	20030708h	Measurement bits, 1 byte
	4	PDO mapping for fourth application object to be mapped	unsigned 32	co	20030808h	Sensor status bits, 1 byte
	5	PDO mapping for fifth application object to be mapped	unsigned 32	co	20040008h	Temperature, 1 byte
2000h		Time-related sensor parameters	record			
	0	Number of entries	unsigned 8	ro	02h	Largest sub-index
	1	Operating hours counter ¹	unsigned 32	ro		Sensor operating time in seconds
	2	Operating hour time stamp of the measurement ¹	unsigned 32	ro		Time stamp of the last measurement
2001h		ISO measurement	record			
	0	Number of entries	unsigned 8	ro	04h	Largest sub-index
	1	ISO 4 μm ¹	unsigned 8	ro		
	2	ISO 6 μm ¹	unsigned 8	ro		
	3	ISO 14 μm ¹	unsigned 8	ro		
	4	ISO 21 μm ¹	unsigned 8	ro		

Communication profile						
Idx	SIdx	Name	Type	Attr.	Standard	Comments
2002h		SAE measurement	record			
	0	Number of entries	unsigned 8	ro	04h	Largest sub-index
	1	SAE 4 μm^1	unsigned 8	ro		Offset of two to display 000, 00 and 0, applies to all classes: 0 = SAE 000 1 = SAE 00 2 = SAE 0 3 = SAE 1 4 = SAE 2...
	2	SAE 6 μm^1	unsigned 8	ro		
	3	SAE 14 μm^1	unsigned 8	ro		
	4	SAE 21 μm^1	unsigned 8	ro		
2003h		Condition monitoring bit field	array			
	0	Number of entries	unsigned 8	ro	08h	Largest sub-index
	1	Oil-specific bits ¹	unsigned 8	ro		0 = Conc. limit exceeded (C >= ISO 23) 1 = High flow (F > 400) 2 = Low flow (F < 50) 3 = Measured values not plausible (air ..) ISO (i+1) >= ISO(i) 4 = AutoMode: MessZeit reached 5 = Autoparts not reached 6 = Concentration too low
	2	Reserved	unsigned 8	ro		
	3	Reserved	unsigned 8	ro		
	4	Reserved	unsigned 8	ro		
	5	Reserved	unsigned 8	ro		
	6	Reserved	unsigned 8	ro		
	7	Measurement information ¹	unsigned 8	ro		0 = Measurement in progress 1 = Measurement mode auto 2 = Measurement mode 1/0 3 = Measurement mode manual 4 = Alarm mode filter / standard
	8	Sensor alarm ¹	unsigned 8	ro		0 = High laser current (I > 2.8 mA) 1 = Low laser current (I < 1 mA) 2 = High photo voltage (U > 4 V) 3 = Low photo voltage (U < 4 V) 4 = High temperature (T > 80 °C) 5 = Low temperature (T < -20 °C)
2004h	0	Sensor temperature ¹	signed 8	ro		Oil temperature in °C
2005h	0	Flow index	unsigned 16	ro		Flow index (0 ... 400)
2020h		Command	unsigned 8	wo		1 = Measurement start 2 = Measurement stop
2030h		Measurement settings	record			
	0	Number of entries	unsigned 8	ro	2h	Largest sub-index
	1	Measuring time	unsigned 32	rw		Measuring time in s
	2	Waiting time	unsigned 32	rw		Time between two measurements
2031h		Start settings	record			
	0	Number of entries	unsigned 8	ro	1h	Largest sub-index
	1	Start mode	unsigned 16	rw	0h	0 = Network with NMT master (Init => PreOp => Start_Remote_Node => Operational) > 0 = Network without NMT master (Init => Operational)

Communication profile						
Idx	SIdx	Name	Type	Attr.	Standard	Comments
2100h		Read memory control functions	record			
	0	Number of entries	unsigned 8	ro	3h	Largest sub-index
	1	Size of the history memory	unsigned 32	ro	Device-dependent	Memory size in datasets
	2	History memory used	unsigned 32	ro		Assigned datasets in the memory (internally corresponds to the write pointer)
	3	Read pointer, data set	unsigned 32	rw		Auto-incremental read pointer to a data set for reading the history memory; between 0 and the current write pointer
2101h	0	Memory reading starts, segmented SDO data upload	unsigned 16	ro		Before reading, a suitable pointer must be set (using 2100sub3), data set size will be sent back after reading; thus, a standardized "segmented SDO upload" is initiated; please note: Change a toggle bit for every data set and set the corresponding bit at the end of the complete transmission

¹ Mapped to PDO

9.4.4 CAN J1939

Please contact our customer service if you need information about the implementation of the CAN J1939 protocol.

10 Maintenance and repair

10.1 Cleaning and care

NOTICE

Improper cleaning!

Early wear, malfunctions! Risk of damage! Damage to property!

- ▶ Cover all openings with the appropriate protective threads in order to prevent cleaning agents from penetrating the system.
- ▶ Check that all seals and electric plug-in connections are firmly fitted to prevent the penetration of cleaning agents.
- ▶ Do not use aggressive cleaning agents for the external cleaning. Clean the product using a suitable cleaning liquid.
- ▶ Use exclusively residue-free industrial wipes to clean the online particle monitor.
- ▶ Do not use a high-pressure washer.
- ▶ Do not use compressed air for the cleaning at functional interfaces like e.g. in sealing areas.
- ▶ Use clean oil or solvents such as isopropanol to clean the cell.

10.2 Maintenance

If used as intended, the online particle monitor is maintenance-free.

10.3 Repair



Hengst offers a wide range of repair services for the online particle monitor.

10.4 Calibration

The particle counter is calibrated relying on ISO 11943.

The equipment that is used for the calibration is calibrated first according to ISO 11171 and can thus be traced back to NIST SRM 2806A.

The calibration certificate of the particle counter has an initial validity of 18 months.

Subsequent certificates will be issued with a validity of 12 months.

10.4.1 Calibration note

The particle counter indicates the need for calibration with a message on the display.



Have the particle counter calibrated by the manufacturer.

- ▶ Press the  input key for 2 seconds to acknowledge the message.
- ▶ The message appears again after 500, 800 and 900 hours.
- ▶ After 1000 hours, the message flashes at a 2-second interval.
- ▶ However, the particle counter can be operated completely and provides measurement results at all times

You can see the remaining hours up to the appearance of the first message („HOURSCAL“) on the particle counter's menu under „*SENSORPARAM > OPERATING HOURS*“.

11 Disposal

- ▶ When disposing of the online particle monitor, comply with the country-specific provisions and regulations.

The disposal requires special attention if the online particle monitor still contains hydraulic fluid residues

11.1 Environmental protection

Careless disposal of the online particle monitor and the hydraulic fluid could lead to environmental pollution.

- ▶ Thus, dispose of the online particle monitor and the hydraulic fluid in accordance with the national regulations of your country and/or your company-internal specifications/procedures.
- ▶ Dispose of hydraulic fluid residues according to the respective safety data sheets valid for these hydraulic fluids.

12 Extension and modification

You will be considered responsible for any extensions to or modifications of the online particle monitor.

If you undertake any extensions to or modifications of the product marketed by Hengst, this means you are changing the condition of the product as supplied. Any statements made by Hengst regarding this product will then become invalid.

- ▶ If you have any questions, please contact with hydraulicfilter@hengst.de directly.

12.1 Optional accessories



You can order optional accessories for the online particle monitor.

More information on the accessories is contained in data sheet 51460, see chapter 1.2 "Required and amending documentation".

13 Troubleshooting

13.1 How to proceed for troubleshooting

- ▶ Always work systematically and focused, even when under time pressure. Random, thoughtless changing of settings might result in the inability to restore the original cause of error.
- ▶ First, get a general overview of how your product functions in conjunction with the overall system.
- ▶ Try to find out whether the product has worked properly in conjunction with the overall system before the error occurred first.
- ▶ Try to determine any changes of the overall system in which the product is integrated:
 - Were there any changes to the product's operating conditions or area of application?
 - Were there any changes (e. g. refittings) or have repairs been carried out at the overall system (machine/system, electrical systems, control) or at the product?
If so: What were they?
 - Was the product or machine used as intended?
 - How did the fault become apparent?
- ▶ Try to get a clear idea of the cause of the error. Ask the direct (machine) operator.

13.2 Error messages

Table 11: Error messages

No communication at the Com port or current outputs < 4 mA	
Cause	Measure
Cable is not correctly connected	▶ Connect the supply and/or communication cable correctly.
Operating voltage is outside the prescribed range	▶ Operate the sensor in the range between 9 ... 36 V DC.
Communication bus incorrectly configured	▶ Check the settings on the "Communication" menu.
No serial communication	
Cause	Measure
Faulty interface configuration	▶ Check whether the interface parameters (9600, 8,1, N, N) in the OPM II and in the PC are correctly set.
Incorrect COM port	▶ Check and correct the COM port.
Faulty writing of the sensor commands	▶ Check the writing of the sensor commands; the commands are case sensitive.
NumLock key deactivated	▶ Activate the NumLock key.
Incorrect or defective cable	▶ Ensure that the cable used is suitable for this application. ▶ Check whether the cable is defective.

Identical measured values in all size classes

Cause	Measure
Air in the oil	<ul style="list-style-type: none"> ▶ Connect the OPM II on the pressure side. ▶ Increase the distance to the pump. ▶ Increase the operating pressure within the specified range.

All size channels display the value 0/0/0/0

Cause	Measure
No volumetric flow	<ul style="list-style-type: none"> ▶ Check the supply and return lines for correct installation. ▶ Increase the operating pressure within the specified range.
There is no valid measurement result	<ul style="list-style-type: none"> ▶ Check the configuration and the measurement mode. ▶ Make sure that a measurement begins and is completed.
Measurement cell soiled The symbol flashes on the display ▶	<ul style="list-style-type: none"> ▶ Clean the particle counter with clean oil or solvent such as Isopropanol. ▶ Flush with clean oil in the opposite direction.
Measurement cell defective The symbol flashes on the display ▶	<ul style="list-style-type: none"> ▶ Contact Hengst Filtration GmbH.

Incorrect measurement of the analog current outputs

Cause	Measure
Incorrect parameter is output	<ul style="list-style-type: none"> ▶ Correct the assignment of the measured values to the current outputs.

**“no valid application” appears constantly on the display
The device keeps restarting**

Cause	Measure
The basic system has a fault. All communication lines are deactivated automatically.	<ul style="list-style-type: none"> ▶ Contact Hengst Filtration GmbH.

Laser current high / photo voltage low

Cause	Measure
Air in the oil	<ul style="list-style-type: none"> ▶ Connect the OPM II on the pressure side. ▶ Increase the distance to the pump. ▶ Increase the operating pressure within the specified range
Measurement cell soiled	<ul style="list-style-type: none"> ▶ Clean the OPM II using clean oil or solvents such as isopropanol. ▶ Flush with clean oil in the opposite direction.



If you could not remedy the occurred error, please contact with hydraulicfilter@hengst.de directly.

13.3 Error Code

OPM II Collects various errors, information and operating states and combines these into four 16-bit values, the ERC (error code).

Table 12: ERC

Bit	ECR 1	ECR 2	ECR 3	ECR 4
0		First limit value calibration (S1) reached		Laser current too large
1		Last limit value calibration (S5) reached		Laser current too small
2				Detector voltage too small
3				Detector voltage too large
4				Temperature >80°C
5				Temperature <-20°C
6				
7				Measurement mode = Automatic
8	Concentration ≥ ISO 23			Measurement running
9	Flow too high (Flow < 50)			Measurement mode = timed
10	Flow too low (Flow > 400)			Measurement mode = Digital I/O
11	ISO(i+1) ≥ ISO(i)			Measurement mode = Key
12				Alarm mode: 0= Standard 1= Filter
13	Autoparts not reached			Power Up = 1 before first measurement
14	Concentration ≤ ISO 9			Alarm concentration
15				Alarm temperature

13.4 Errors on the display

After each measurement, Patrick checks various conditions. If the check produces errors during measurement or on the instrument, then these are output on the display.

The errors are output on the left of the display. The error text flashes. If more than one error is displayed, then the error texts are output so that they alternate.

Table 13: Error texts

Error text	Meaning	Error Code
FL LO	Flow too low	ECR 1, Bit 10
FL HI	Flow too high	ECR 1, Bit 9
CELL	Error in measurement cell	ERC 4, Bit 0, 1, 2 or 3
C LO	Concentration too low	ERC 1, Bit 14
C HI	Concentration too high	ERC 1, Bit 8
2 CLN	Measurement result not plausible	ERC 1, Bit 13

14 Technical data

Table 14: Technical data

Sensor data		Size	Unit
Operating conditions			
Admissible operating pressure	Dynamic	420 [6091]	bar [psi]
Ambient temperature		-20 ... 80	°C
Humidity		0 ... 95	%
Storage conditions			
Ambient temperature		-20 ... 85	°C
Humidity		0 ... 95	%
Fluids			
Admissible fluids	Mineral and ester fluids; poly-alpha-olefins		
Temperature fluid		-20 ... 80	°C
Fluid connections	2 x threaded coupling for screw connection M16 x 2		
Admissible flow		50 ... 400	ml/min
Wetted materials	Stainless steel, sapphire, NBR		
Sealing material	NBR		
Voltage supply		9 ... 36	V DC
Current consumption		Max. 300	mA
Current outputs		4 ... 20	mA
Interfaces	RS 232, CANopen		
Alarm contact	Open collector output		
Electrical connection	8-pin connector M12x1		
Measurement range according to ISO 4406:99		0 ... 24	Ordinal number (OZ)
Calibrated measurement range		10 ... 22	Ordinal number (OZ)
Measurement accuracy		±1.0	Ordinal number (OZ)

Hengst Filtration GmbH

Hardtwaldstr. 43
68775 Ketsch, Germany
Phone +49 (0) 62 02 / 6 03-0
hydraulicfilter@hengst.de
www.hengst.com

For your local contact, please refer to:

www.hengst.com/hydraulic